

LRM-202-#

PYROMID® multi channel pyroelectric detector

Description:

dual channel; TO46 housing; small chip size; thermal compensation; JFET; voltage mode;



Housing:

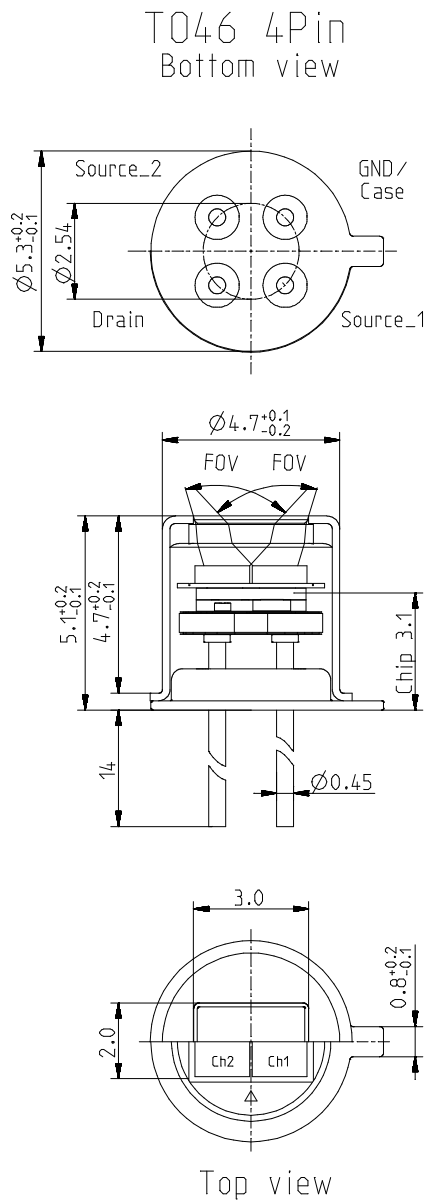

Pin Assignment:

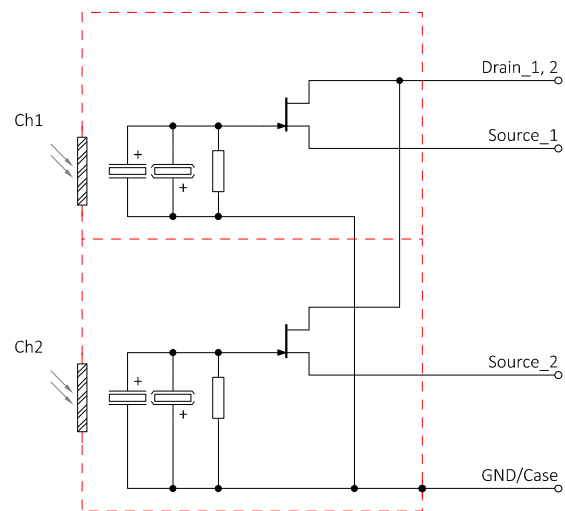

Maximum current between Case and the "Case"-Pin 10 mA!

Frequency Response:

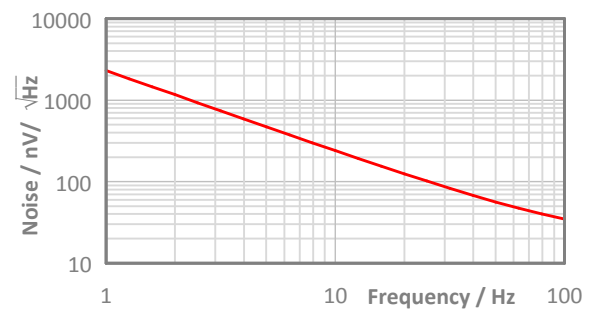
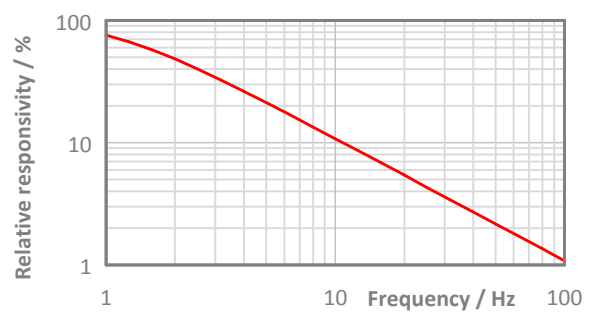

LRM-202-#

PYROMID® multi channel pyroelectric detector

Test Circuit:

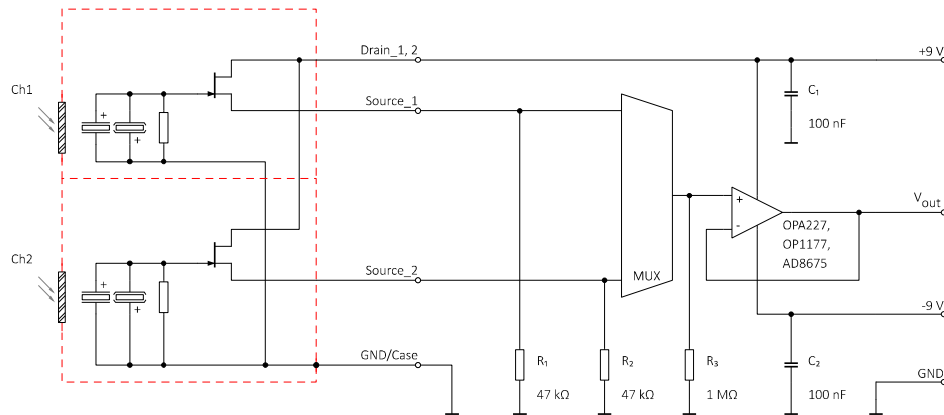

Parameters:

Aperture size	nom	3.0 × 2.0 mm ²
Element size / type	nom	1.2 × 0.8 mm ² lithium-tantalate with black layer
Thermal time constant	typ	75 ms
Electrical time constant	typ	3 s
Polarity	nom	Positive signal by positive IR flux change
Voltage responsivity (rms) {500 K, 10 Hz, 25 °C, without filter/window}	min	560 V/W
Noise density (rms) {10 Hz, BW 1 Hz, 25 °C}	max	420 nV/√Hz
Detectivity {500 K, 10 Hz, BW 1 Hz, 25 °C, without filter/window}	typ	2.0E+08 cmVHz/W
Offset voltage {opt. Drain current = 10 ... 100 μA}	nom	0.4 ... 1.5 V
Drain source voltage	max	18 V
Operating / Storage temperature	nom	-25 ... +85 °C
IR filter		Combinations of all InfraTec standard narrow band pass filters are available. Customized filters upon request.
Filter sizes	nom	Rectangular filters: (1.85 × 1.45) mm ±0.1 mm Circular filters: not applicable Standard thickness: 0.50 mm +0.2/-0.1 mm
Aperture window		Selected by InfraTec for best channel filter matching
Aperture window sizes	nom	Rectangular filters: (3.3 × 2.3) mm +0/-0.05 mm Standard thickness: 0.50 mm ±0.1 mm
Field of View	min	60° (with filter: silicon substrate; 0.5 mm thick and aperture: Si ARC; 0.5 mm thick)

This preliminary datasheet contains information regarding a product InfraTec is considering for production release. Due to this state all data are for information only.

InfraTec reserves the right to change these specifications at any time without notification.